



中国认可  
国际互认  
检测  
TESTING  
CNAS L0220

Test Report issued under the responsibility of:



Total Quality. Assured.

<b>TEST REPORT</b> <b>IEC 62116</b> <b>Test procedure of islanding prevention measures for utility-interconnected photovoltaic inverters</b>	
Report Number .....	191122136GZU-004
Date of issue .....	26 Dec 2019
Total number of pages.....	14 Pages
Name of Testing Laboratory preparing the Report.....	Intertek Testing Services Shenzhen Ltd. Guangzhou Branch Block E, No.7-2 Guang Dong Software Science Park, Caipin Road, Guangzhou Science City, GETDD, Guangzhou, China
Applicant's name.....	Shenzhen SOFAR SOLAR Co., Ltd.
Address .....	401, Building 4, AnTongDa Industrial Park, District 68, XingDong Community, XinAn Street, BaoAn District, Shenzhen, China
<b>Test specification:</b>	
Standard .....	IEC 62116:2014
Test procedure .....	Type approval
Non-standard test method.....	N/A
Test Report Form No.....	IEC62116B
Test Report Form(s) Originator.....	TÜV SÜD Product Service GmbH
Master TRF .....	Dated 2017-11-03
<b>Copyright © 2017 IEC System of Conformity Assessment Schemes for Electrotechnical Equipment and Components (IECEE System). All rights reserved.</b> This publication may be reproduced in whole or in part for non-commercial purposes as long as the IECEE is acknowledged as copyright owner and source of the material. IECEE takes no responsibility for and will not assume liability for damages resulting from the reader's interpretation of the reproduced material due to its placement and context. If this Test Report Form is used by non-IECEE members, the IECEE/IEC logo and the reference to the CB Scheme procedure shall be removed. <b>This report is not valid as a CB Test Report unless signed by an approved CB Testing Laboratory and appended to a CB Test Certificate issued by an NCB in accordance with IECEE 02.</b>	
<b>General disclaimer:</b>	
The test results presented in this report relate only to the object tested. This report shall not be reproduced, except in full, without the written approval of the Issuing CB Testing Laboratory. The authenticity of this Test Report and its contents can be verified by contacting the NCB, responsible for this Test Report.	



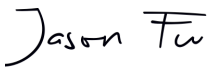















<b>Test item description</b> ..... :	Solar Grid-tied inverter																																														
<b>Trade Mark</b> ..... :																																															
<b>Manufacturer</b> .....	Same as applicant																																														
<b>Model/Type reference</b> .....	SOFAR 27500TL-LV, SOFAR 33000TL-LV																																														
<b>Ratings</b> .....	<table border="1"> <thead> <tr> <th>Model</th> <th>SOFAR 27500TL-LV</th> <th>SOFAR 33000TL-LV</th> </tr> </thead> <tbody> <tr> <td>Max.PV voltage</td> <td colspan="2">1000Vdc</td> </tr> <tr> <td>MPPT voltage</td> <td colspan="2">250-950Vdc</td> </tr> <tr> <td>Max.input current</td> <td>40A/30A/30A</td> <td>40A/40A/40A</td> </tr> <tr> <td>PV Isc</td> <td>48A/36A/36A</td> <td>48A/48A/48A</td> </tr> <tr> <td>Nominal output voltage</td> <td colspan="2">3W/N/PE 127/220 Vac</td> </tr> <tr> <td>Nominal output Frequency</td> <td colspan="2">60Hz</td> </tr> <tr> <td>Max.output current</td> <td>80A</td> <td>90A</td> </tr> <tr> <td>Nominal output power</td> <td>27500 W</td> <td>33000 W</td> </tr> <tr> <td>Max.output power</td> <td>27500 VA</td> <td>33000 VA</td> </tr> <tr> <td>Power factor range</td> <td colspan="2">0.8Leading~0.8Lagging</td> </tr> <tr> <td>Safety level</td> <td colspan="2">Class I</td> </tr> <tr> <td>Ingress Protection</td> <td colspan="2">IP 65</td> </tr> <tr> <td>Operation Ambient Temperature</td> <td colspan="2">-25°C - +60°C</td> </tr> <tr> <td>Software version</td> <td colspan="2">V2.00</td> </tr> </tbody> </table>		Model	SOFAR 27500TL-LV	SOFAR 33000TL-LV	Max.PV voltage	1000Vdc		MPPT voltage	250-950Vdc		Max.input current	40A/30A/30A	40A/40A/40A	PV Isc	48A/36A/36A	48A/48A/48A	Nominal output voltage	3W/N/PE 127/220 Vac		Nominal output Frequency	60Hz		Max.output current	80A	90A	Nominal output power	27500 W	33000 W	Max.output power	27500 VA	33000 VA	Power factor range	0.8Leading~0.8Lagging		Safety level	Class I		Ingress Protection	IP 65		Operation Ambient Temperature	-25°C - +60°C		Software version	V2.00	
Model	SOFAR 27500TL-LV	SOFAR 33000TL-LV																																													
Max.PV voltage	1000Vdc																																														
MPPT voltage	250-950Vdc																																														
Max.input current	40A/30A/30A	40A/40A/40A																																													
PV Isc	48A/36A/36A	48A/48A/48A																																													
Nominal output voltage	3W/N/PE 127/220 Vac																																														
Nominal output Frequency	60Hz																																														
Max.output current	80A	90A																																													
Nominal output power	27500 W	33000 W																																													
Max.output power	27500 VA	33000 VA																																													
Power factor range	0.8Leading~0.8Lagging																																														
Safety level	Class I																																														
Ingress Protection	IP 65																																														
Operation Ambient Temperature	-25°C - +60°C																																														
Software version	V2.00																																														

Responsible Testing Laboratory (as applicable), testing procedure and testing location(s):		
<input checked="" type="checkbox"/>	<b>CB Testing Laboratory:</b>	Intertek Testing Services Shenzhen Ltd. Guangzhou Branch
Testing location/ address .....		Block E, No.7-2 Guang Dong Software Science Park, Caipin Road, Guangzhou Science City, GETDD, Guangzhou, China
Tested by (name, function, signature) .....		Sunny Lin Engineer 
Approved by (name, function, signature) ..		Jason Fu Technical Team Leader 
<input type="checkbox"/>	<b>Testing procedure: CTF Stage 1:</b>	N/A
Testing location/ address .....		N/A
Tested by (name, function, signature) .....		N/A
Approved by (name, function, signature) ..		N/A
<input type="checkbox"/>	<b>Testing procedure: CTF Stage 2:</b>	N/A
Testing location/ address .....		N/A
Tested by (name + signature).....		N/A
Witnessed by (name, function, signature) . :		N/A
Approved by (name, function, signature) .. :		N/A
<input type="checkbox"/>	<b>Testing procedure: CTF Stage 3:</b>	N/A
<input type="checkbox"/>	<b>Testing procedure: CTF Stage 4:</b>	N/A
Testing location/ address .....		N/A
Tested by (name, function, signature) .....		N/A
Witnessed by (name, function, signature) . :		N/A
Approved by (name, function, signature) .. :		N/A
Supervised by (name, function, signature) :		N/A

<b>List of Attachments (including a total number of pages in each attachment):</b> N/A	
<b>Summary of testing:</b>	
<b>Tests performed (name of test and test clause):</b> All applicable tests	<b>Testing location:</b> Intertek Testing Services Shenzhen Ltd. Guangzhou Branch Block E, No.7-2 Guang Dong Software Science Park, Caipin Road, Guangzhou Science City, GETDD, Guangzhou, China
<b>Summary of compliance with National Differences (List of countries addressed):</b> N/A	
<input checked="" type="checkbox"/> <b>The product fulfils the requirements of IEC 62116:2014</b>	

**Copy of marking plate:**

The artwork below may be only a draft. The use of certification marks on a product must be authorized by the respective NCBS that own these marks.

 Solar Grid-tied Inverter		 Solar Grid-tied Inverter	
Model No:	SOFAR 27500TL-LV	Model No:	SOFAR 33000TL-LV
Max.DC Input Voltage	1000V	Max.DC Input Voltage	1000V
Operating MPPT Voltage Range	250~950V	Operating MPPT Voltage Range	250~950V
Max. Input Current	40A/30A/30A	Max. Input Current	40A/40A/40A
Max. PV Isc	48A/36A/36A	Max. PV Isc	48A/48A/48A
Nominal Grid Voltage	3/N/PE, 127/220Vac	Nominal Grid Voltage	3/N/PE, 127/220Vac
Max. Output Current	80A	Max. Output Current	90A
Nominal Grid Frequency	60Hz	Nominal Grid Frequency	60Hz
Nominal Output Power	27500W	Nominal Output Power	33000W
Max. Output Power	27500VA	Max. Output Power	33000VA
Power Factor	>0.99(adjustable+/-0.8)	Power Factor	>0.99(adjustable+/-0.8)
Ingress Protection	IP65	Ingress Protection	IP65
Operating Temperature Range	-25°C~+60°C	Operating Temperature Range	-25°C~+60°C
Protective Class	Class I	Protective Class	Class I
Made in China		Made in China	
Manufacturer : Shenzhen SOFAR SOLAR Co.,Ltd. Address : 401, Building 4, AnTongDa Industrial Park, District 68, XingDong Community,XinAn Street, BaoAn District, Shenzhen, China VDE0126-1-1,VDE-AR-N4105,G99,IEC61727, IEC62116,AS4777		Manufacturer : Shenzhen SOFAR SOLAR Co.,Ltd. Address : 401, Building 4, AnTongDa Industrial Park, District 68, XingDong Community,XinAn Street, BaoAn District, Shenzhen, China VDE0126-1-1,VDE-AR-N4105,G99,IEC61727, IEC62116,AS4777	
       		       	

**Note:**

1. The above markings are the minimum requirements required by the safety standard. For the final production samples, the additional markings which do not give rise to misunderstanding may be added.
2. Label is attached on the side surface of enclosure and visible after installation.

<b>Test item particulars</b> .....:	
<b>Classification of installation and use</b> .....: Fixed and outdoor use	
<b>Supply Connection</b> .....: Permanent connection	
.....:	
<b>Possible test case verdicts:</b>	
- test case does not apply to the test object.....: N/A	
- test object does meet the requirement.....: P (Pass)	
- test object does not meet the requirement.....: F (Fail)	
<b>Testing</b> .....:	
<b>Date of receipt of test item</b> .....: 22 Nov 2019	
<b>Date (s) of performance of tests</b> .....: 23 Nov 2019 to 26 Dec 2019	
<b>General remarks:</b>	
<p>"(See Enclosure #)" refers to additional information appended to the report.          "(See appended table)" refers to a table appended to the report.  <b>Throughout this report a <input type="checkbox"/> comma / <input checked="" type="checkbox"/> point is used as the decimal separator.</b>  <b>This report shall be used together with the report 191122136GZU-003.</b></p>	
<b>Manufacturer's Declaration per sub-clause 4.2.5 of IEC 60335-1:</b>	
The application for obtaining a CB Test Certificate includes more than one factory location and a declaration from the Manufacturer stating that the sample(s) submitted for evaluation is (are) representative of the products from each factory has been provided .....:	<input type="checkbox"/> <b>Yes</b> <input checked="" type="checkbox"/> <b>Not applicable</b>
<b>When differences exist; they shall be identified in the General product information section.</b>	
<b>Name and address of factory (ies)</b> .....: Dongguan SOFAR SOLAR Co., Ltd. 1F - 6F, Building E, No. 1 JinQi Road, Bihu Industrial Park, Wulian Village, Fenggang Town, Dongguan City, China	

**General product information:**

The Solar converter is a three-phase type.

The unit is providing EMC filtering at the output toward mains. The unit does not provide galvanic separation from input to output (transformerless). The output is switched off redundant by the high power switching bridge and two relays. This assures that the opening of the output circuit will also operate in case of one error.

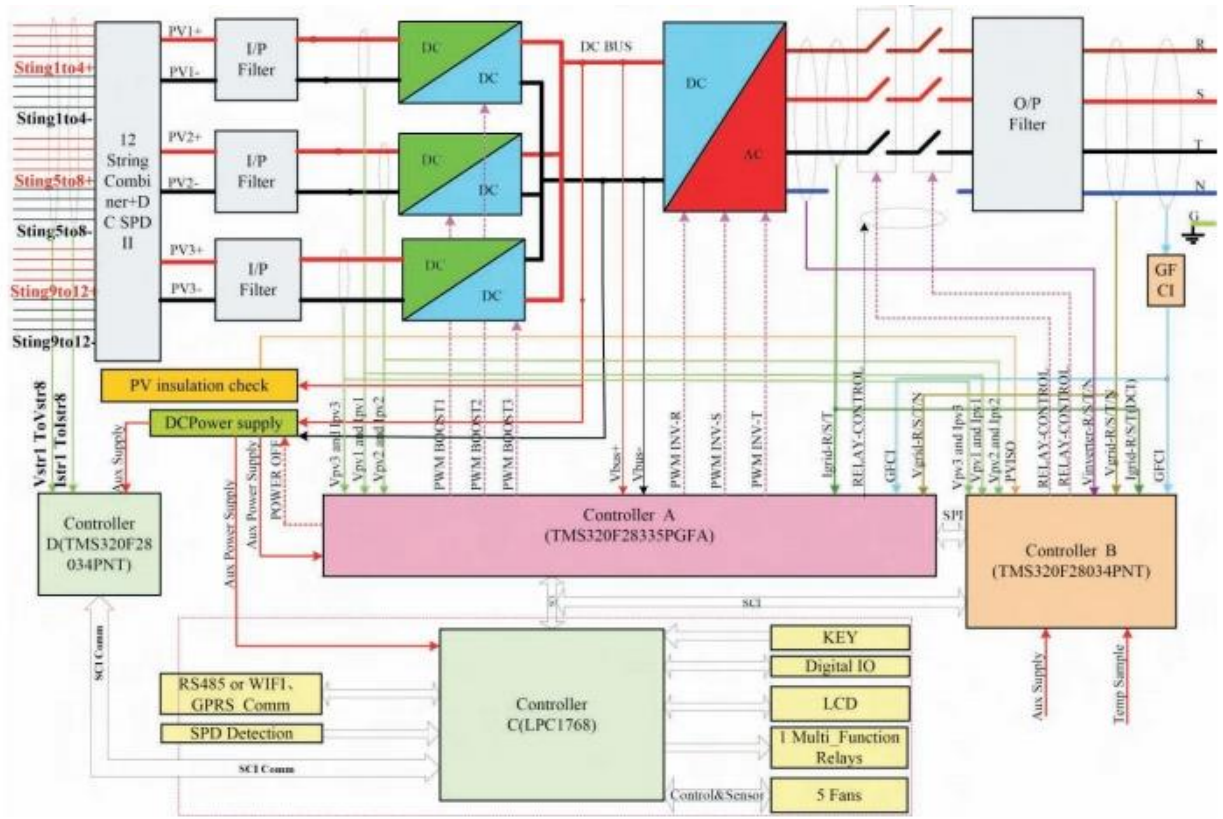

The internal control is redundant built. It consists of Main DSP and slave DSP.

The Main DSP can control the relays, measures voltage, and frequency, AC current with injected DC, insulation resistance and residual current. In addition, it tests the array insulation resistance and the RCMU circuit before each start up.

The slave DSP is using for detecting residual current, also can open the relays independently and communicate with Main DSP.

The unit provides two relays in series on Line conductors. When single-fault applied to one relay, alarm an error code in display panel, another redundant relay provides basic insulation maintained between the PV array and the mains. All the relays are tested before starting up. Both controllers (Main DSP, Slave DSP) can open the relays.

**Difference of models:**

All models are identical in hardware except the output power derating by software.

Other than special notice, the model SOFAR 33000TL-LV was as the representative test model in this report.

<b>IEC 62116</b>			
Clause	Requirement + Test	Result - Remark	Verdict
<b>4</b>	<b>Testing circuit</b>		
	The testing circuit shown in Figure 1 is employed.		P
	Similar circuits are used for three-phase output.		P
	Parameters to be measured are shown in Table 1 and Figure 1. Parameters to be recorded in the test report are discussed in Clause 7.		P
<b>5</b>	<b>Testing equipment</b>		
<b>5.1</b>	<b>Measuring instruments</b>		<b>P</b>
	The waveform measurement/capture device is able to record the waveform from the beginning of the islanding test until the EUT ceases to energize the island.	Waveform caught from the switch open and the EUT cease to energize	P
	For multi-phase EUT, all phases are monitored.		P
	A waveform monitor designed to detect and calculate the run-on time may be used.		P
	For multi-phase EUT, the test and measurement equipment is recorded each phase current and each phase-to-neutral or phase-to-phase voltage, as appropriate, to determine fundamental frequency active and reactive power flow over the duration of the test.		P
	A sampling rate of 10 kHz or higher is recommended. The minimum measurement accuracy is 1 % or less of rated EUT nominal output voltage and 1 % or less of rated EUT output current		P
	Current, active power, and reactive power measurements through switch S1 used to determine the circuit balance conditions report the fundamental (50 Hz or 60 Hz) component.		P
<b>5.2</b>	<b>DC power source</b>		
<b>5.2.1</b>	<b>General</b>		<b>P</b>
	A PV array or PV array simulator (preferred) may be used. If the EUT can operate in utility-interconnected mode from a storage battery, a DC power source may be used in lieu of a battery as long as the DC power source is not the limiting device as far as the maximum EUT input current is concerned.	Topcon PV simulator used	P
	The DC power source provides voltage and current necessary to meet the testing requirements described in Clause 6.		P
<b>5.2.2</b>	<b>PV array simulator</b>		<b>P</b>



<b>IEC 62116</b>			
Clause	Requirement + Test	Result - Remark	Verdict
	The tests are conducted at the input voltage defined in Table 2 below, and the current is limited to 1,5 times the rated photovoltaic input current, except when specified otherwise by the test requirements.	Topcon PV simulator used	P
	A PV array simulator is recommended, however, any type of power source may be used if it does not influence the test results.		P
<b>5.2.3</b>	<b>Current and voltage limited DC power supply with series resistance</b>		N/A
	A DC power source used as the EUT input source is capable of EUT maximum input power (so as to achieve EUT maximum output power) at minimum and maximum EUT input operating voltage.		N/A
	The power source provides adjustable current and voltage limit, set to provide the desired short circuit current and open circuit voltage when combined with the series and shunt resistance described below.		N/A
	A series resistance (and, optionally, a shunt resistance) is selected to provide a fill factor within the range: Output power: Sufficient to provide maximum EUT output power and other levels specified by test conditions of table 5. Response speed: The response time of a simulator to a step in output voltage, due to a 5% load change, results in a settling of the output current to within 10% of its final value in less than 1ms. Stability: Excluding the variations caused by the EUT MPPT, simulator output power remains stable within 2 % of specified power level over the duration of the test: from the point where load balance is achieved until the island condition is cleared or the allowable run-on time is exceeded. Power factor: 0.25 to 0.8		N/A
<b>5.2.4</b>	<b>PV array</b>		N/A
	A PV array used as the EUT input source is capable of EUT maximum input power at minimum and maximum EUT input operating voltage.		N/A

<b>IEC 62116</b>													
Clause	Requirement + Test	Result - Remark	Verdict										
	Testing is limited to times when the irradiance varies by no more than 2 % over the duration of the test as measured by a silicon-type pyranometer or reference device. It may be necessary to adjust the array configuration to achieve the input voltage and power levels prescribed in 6.1.		N/A										
<b>5.3</b>	<b>AC power source</b>		P										
	<p>The utility grid or other AC power source may be used as long as it meets the conditions specified in Table 4.</p> <p style="text-align: center;"><small>Table 4 – AC power source requirements</small></p> <table border="1" style="width: 100%; border-collapse: collapse;"> <thead> <tr> <th style="width: 50%; text-align: center;">Items</th> <th style="width: 50%; text-align: center;">Conditions</th> </tr> </thead> <tbody> <tr> <td>Voltage</td> <td>Nominal ±2,0 %</td> </tr> <tr> <td>Voltage THD</td> <td>&lt; 2,5 %</td> </tr> <tr> <td>Frequency</td> <td>Nominal ±0,1 Hz</td> </tr> <tr> <td>Phase angle distance <sup>1)</sup></td> <td>120 ° ± 1,5 °</td> </tr> </tbody> </table> <p><small><sup>1)</sup> Three-phase case only</small></p>	Items	Conditions	Voltage	Nominal ±2,0 %	Voltage THD	< 2,5 %	Frequency	Nominal ±0,1 Hz	Phase angle distance <sup>1)</sup>	120 ° ± 1,5 °		P
Items	Conditions												
Voltage	Nominal ±2,0 %												
Voltage THD	< 2,5 %												
Frequency	Nominal ±0,1 Hz												
Phase angle distance <sup>1)</sup>	120 ° ± 1,5 °												
<b>5.4</b>	<b>AC loads</b>		P										
	On the AC side of the EUT, variable resistance, capacitance, and inductance are connected in parallel as loads between the EUT and the AC power source. Other sources of load, such as electronic loads, may be used if it can be shown that the source does not cause results that are different than would be obtained with passive resistors, inductors, and capacitors.		P										
	All AC loads are rated for and adjustable to all test conditions. The equations for Qf are based upon an ideal parallel RLC circuit. For this reason, non-inductive resistors, low loss (high Qf) inductors, and capacitors with low effective series resistance and effective series inductance are utilized in the test circuit. Iron core inductors, if used, are not exceed a current THD of 2 % when operated at nominal voltage. Load components are conservatively rated for the voltage and power levels expected. Resistor power ratings are chosen so as to minimize thermally-induced drift in esistance values during the course of the test.		P										

<b>IEC 62116</b>			
Clause	Requirement + Test	Result - Remark	Verdict
	Active and reactive power is calculated (using the measurements provided in Table 1) in each of the R, L and C legs of the load so that these parasitic parameters (and parasitics introduced by variacs or autotransformers) are properly accounted for when calculating Qf.		P
<b>6</b>	<b>Test for single or multi-phase inverter</b>		
<b>6.1</b>	<b>Test procedure</b>	<b>(see appended table)</b>	<b>P</b>
	The test uses an RLC load, resonant at the EUT nominal frequency (50 Hz or 60 Hz) and matched to the EUT output power.		P
	For multi-phase EUT, the load is balanced across all phases and the switch S1 as in Figure 1 opens all phases		P
	This test is performed with the EUT conditions as in Table 5, where power and voltage values are given as a percent of EUT full output rating.		P
	a) ..Determine EUT test output power		P
	b) .Adjusting the DC input source		P
	c) .Turn off the EUT and open S1		P
	d) .Adjust the RLC circuit to have $Q_f = 1.0 \pm 0.05$		P
	e) ..Connect the RLC load configured in step d) to the EUT by closing S2		P
	f) ..Open the utility-disconnect switch S1 to initiate the test, Run-on time is recorded.		P
	g) .For test condition A, adjust the real load and only one of the reactive load components to each of the load imbalance conditions shown in the shaded portion of table 6. If any of the recorded run-on times are longer than the one recorded for the rated balance condition, then the non-shaded parameter combinations also require testing.		P
	h) For test condition B and C, adjust the only one reactive load components by approximately 1,0% per test, within a total range of 95% to 105% of the operating point. If run-on times are still increasing at the 95% or 105% points, additional 1% increments have to be taken until run-on times begin decreasing.		P
<b>6.2</b>	<b>Pass/fail criteria</b>		

IEC 62116			
Clause	Requirement + Test	Result - Remark	Verdict
	An EUT is considered to comply with the requirements for islanding protection when each case of recorded run-on time is less than 2 s or meets the requirements of local codes.		P
<b>7</b>	<b>Documentation</b>		
	At a minimum, the following information is recorded and maintained in the test report.		P
	a) Specifications of EUT. Table 8 provides an example of the type of information that is provided.		P
	b) Measurement results. Table 9 provides an example of the type of information that is provided. Actual measured values is to be recorded.		P
	c) Block diagram of test circuit.		P
	d) Specifications of the test and measurement equipment. Table 10 provides an example of the type of information that is provided.		P
	e) Any test configuration or procedure details such as methods of achieving specified load and EUT output conditions.		P
	f) Any additional information required by the testing laboratory's accreditation.		P
	g) Specify the evaluation criterion from clause 6.2 that was utilized to determine if the product passed or failed the test.		P
Annex A	Islanding as it applies to PV systems(Informative)		--
A.1	General		--
A.2	Impact of distortion on islanding		--
Annex B	Test for independent islanding detection device (relay)(Informative)		--
B.1	Introduction		--
B.2	Testing circuit		--
B.3	Testing equipment		--
B.4	Testing procedure		--
B.5	Documentation		--

IEC 62116			
Clause	Requirement + Test	Result - Remark	Verdict

6.1	TABLE: tested condition and run-on time								P
Model	SOFAR 33000TL-LV								
No.	P <sub>EUT</sub> (% of EUT rating)	Reactive load (% of normal)	P <sub>AC</sub>	Q <sub>AC</sub>	Run-on time(ms)	P <sub>EUT</sub> (KW)	Actual Q <sub>f</sub> (Var)	V <sub>DC</sub> (V)	Which load is selected to be adjusted (R or L)
<b>Test condition A</b>									
1	100	100	0	0	1111.0	32.21	1.00	773	/
2	100	100	-5	-5	1072.0	32.21	0.98	773	/
3	100	100	-5	0	1002.0	32.21	0.96	773	/
4	100	100	-5	+5	997.5	32.21	0.93	773	/
5	100	100	0	-5	1029.0	32.21	1.03	773	/
6	100	100	0	+5	969.5	32.21	0.98	773	/
7	100	100	+5	-5	603.0	32.21	1.08	773	/
8	100	100	+5	0	1095.0	32.21	1.06	773	/
9	100	100	+5	+5	1011.0	32.21	1.03	773	/
<b>Test condition B</b>									
10	66	66	0	0	378.0	19.81	1.00	693	/
11	66	66	0	-5	199.0	19.81	1.02	693	L
12	66	66	0	-4	234.5	19.81	1.02	693	L
13	66	66	0	-3	164.5	19.81	1.01	693	L
14	66	66	0	-2	179.0	19.81	1.01	693	L
15	66	66	0	-1	213.5	19.81	1.00	693	L
16	66	66	0	1	328.0	19.81	0.99	693	L
17	66	66	0	2	224.0	19.81	0.99	693	L
18	66	66	0	3	202.5	19.81	0.98	693	L
19	66	66	0	4	174.5	19.81	0.98	693	L
20	66	66	0	5	172.5	19.81	0.97	693	L
<b>Test condition C</b>									
21	33	33	0	0	352.0	10.10	1.00	559	/
22	33	33	0	-5	179.5	10.10	1.02	559	L
23	33	33	0	-4	184.0	10.10	1.01	559	L
24	33	33	0	-3	223.0	10.10	1.01	559	L
25	33	33	0	-2	198.5	10.10	1.01	559	L
26	33	33	0	-1	200.5	10.10	1.00	559	L
27	33	33	0	1	348.0	10.10	1.00	559	L
28	33	33	0	2	255.0	10.10	0.99	559	L
29	33	33	0	3	239.5	10.10	0.98	559	L
30	33	33	0	4	210.5	10.10	0.98	559	L
31	33	33	0	5	207.5	10.10	0.97	559	L

IEC 62116			
Clause	Requirement + Test	Result - Remark	Verdict

Supplementary information:

For test condition A:

If any of the recorded run-on times are longer than the one recorded for the rated balance condition, then the non-shaded parameter combinations also require testing.

For test condition B and C:

If run-on times are still increasing at the 95 % or 105 % points, additional 1 % increments is taken until run-on times begin decreasing.

--- End of test report---